

# Chelsea Sectional Guide Discover micro-weave

Use the grid to re-create your space to scale and cut out the illustrations of the sectional pieces to configure your sectional. Individual sectional pieces are shown, along with some of our most popular sectional configurations.



left-arm chaise, 76" right arm sofa

left-arm sofa

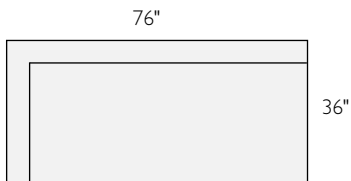

right-arm sofa

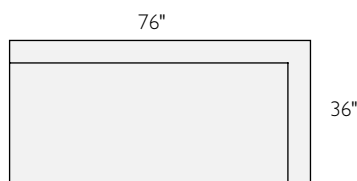

left-arm chaise

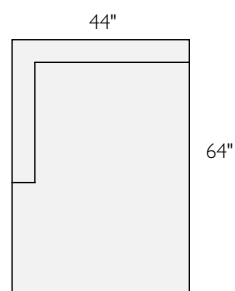

right-arm chaise

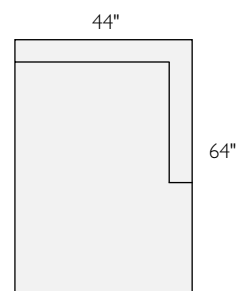

89" sofa\*

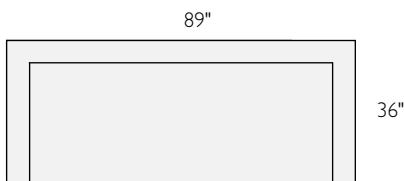

94" sofa

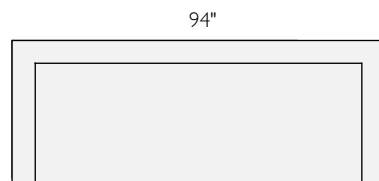

armless chair

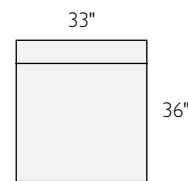

ottoman

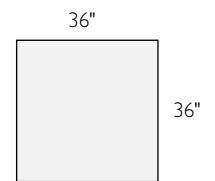

armless sofa

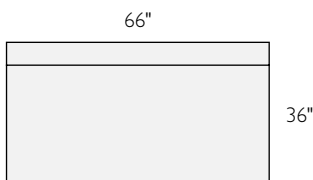

left-back sofa

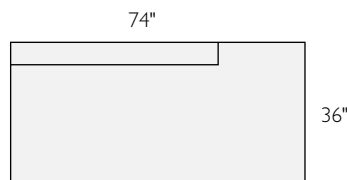

right-back sofa

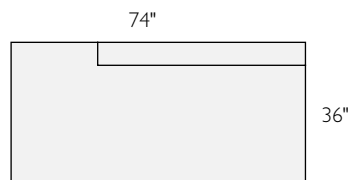

left-arm chaise, right-arm sofa

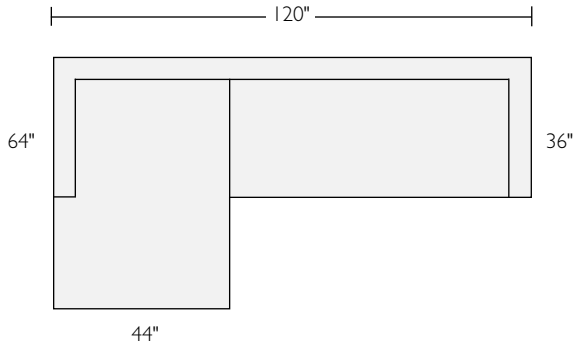

left-arm sofa, right-arm chaise

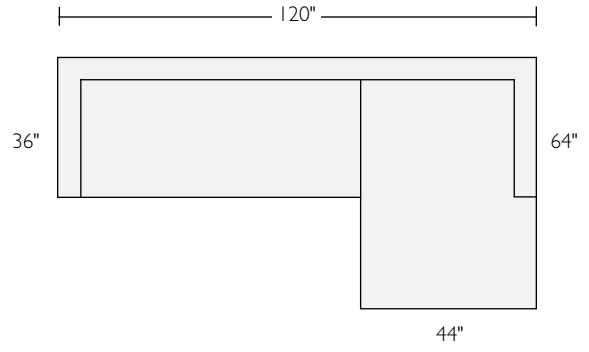

left-arm sofa, 94" sofa

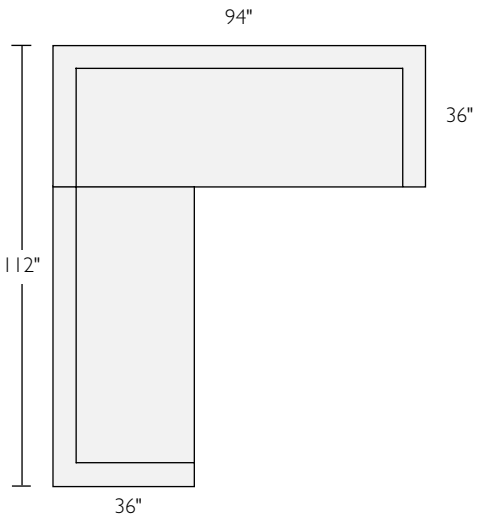

94" sofa, right-arm sofa

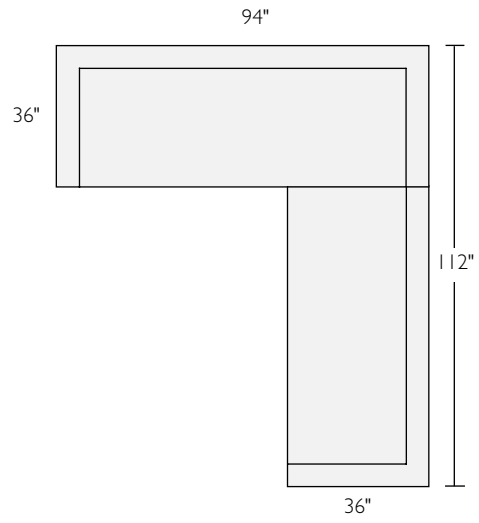

right-back sofa, ottoman, armless sofa

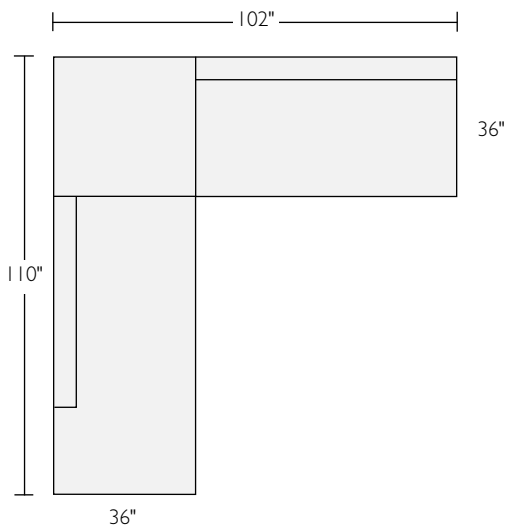

# Create Your Own Configuration

scale: 1 square = 12 inches

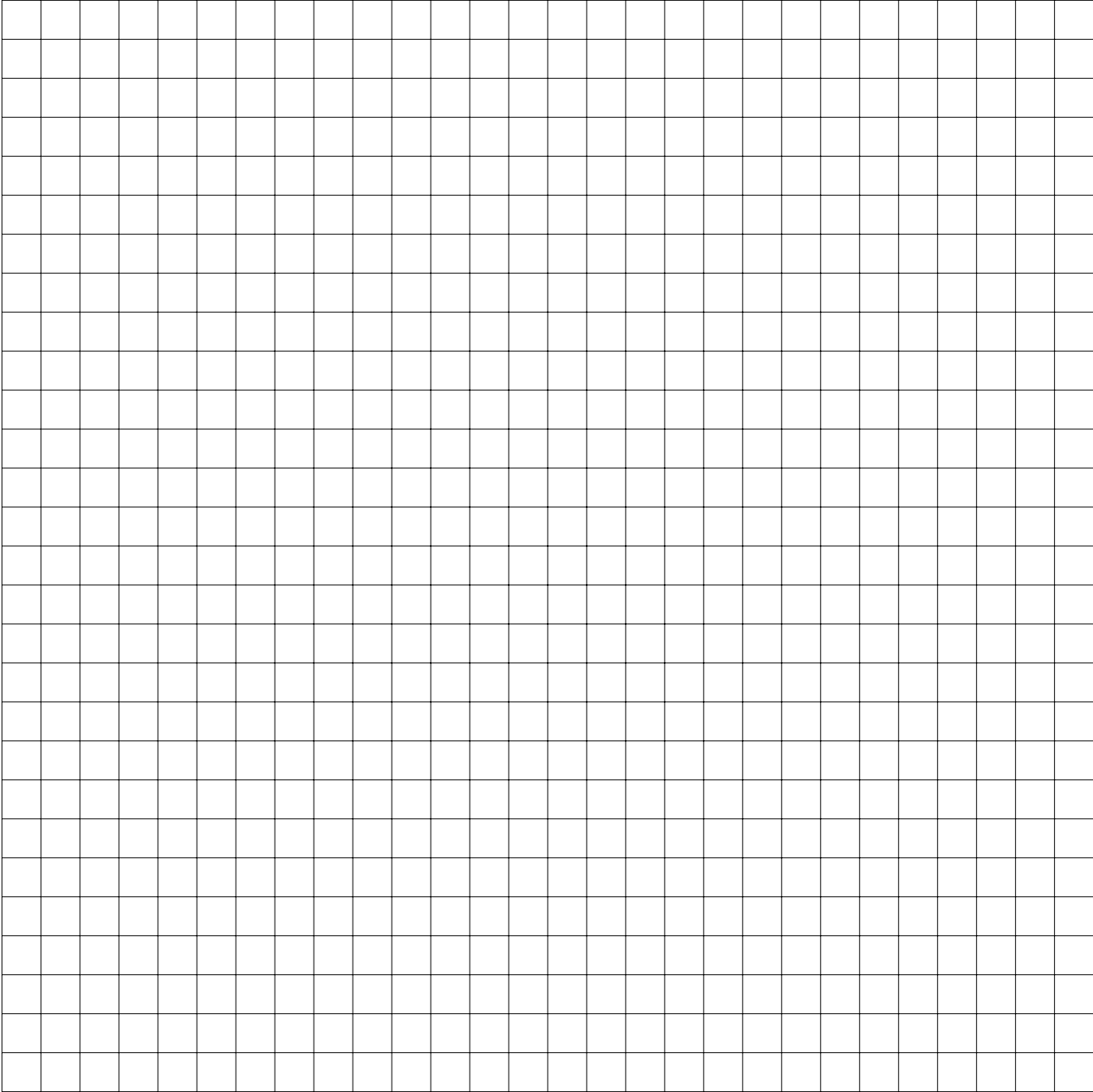

Notes:

---

---

---

\_\_\_\_\_  
Sales order #

\_\_\_\_\_  
Design Associate

\_\_\_\_\_  
Customer name

\_\_\_\_\_  
Delivery date