

# sectional guide: jasper



Jasper sofa with left-arm chaise sectional in Trip Straw.

**Find the perfect Jasper sectional for your space.** Jasper captures everything you're looking for: incredible design, exceptional comfort and options to fit your space. Jasper's mid-20th-century influences are evident in its elegant tapered wood legs and clean lines. Loose back cushions add comfort and a relaxed look to the design.

Use this guide to find the best possible combination of pieces to suit your needs, including our most popular sectional packages or custom options not available in our catalog or at [roomandboard.com](http://roomandboard.com).

**We're here to help you with your selection.** If you have any questions, are ordering custom pieces or personalizing fabric, we're happy to help you with your selection and share pricing and timing information.

**All of our Jasper sectionals feature:**

- wrapped foam cushions
- loose seat and back
- removable 7" legs in mocha
- arm height: 25", seat height 19", seat depth 21", back height 32", overall height 35"

**Trip weave**

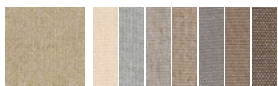

Stocked in straw

Additional colors allow extra time



**Sofa with right-arm chaise sectional in Trip Straw.**



A chaise gives you a comfortable spot to lounge while expanding your seating capacity.

Personalize your sectional. Choose from more than 300 fabrics and select leathers. Call us at 800.301.9720.

We're here to help you with your selection.

If you have questions or would like to order one of these custom pieces, please call us at 800.301.9720.

## jasper sectional pieces

item	dimensions	arm	seat	Trip	
A armless chair	27w 36d 32h	—	27w 21d 19h	275293*	\$699
B corner	36w 36d 32h	—	21w 21d 19h	361190*	\$899
C 31" left-arm chaise	31w 62d 32h	25h	27w 47d 19h	461349*	\$1099
D 31" right-arm chaise	31w 62d 32h	25h	27w 47d 19h	926041*	\$1099
E 37" left-arm wide chaise	37w 60d 32h	25h	33w 45d 19h	990222	\$1199
F 37" right-arm wide chaise	37w 60d 32h	25h	33w 45d 19h	563843	\$1199
G 56" left-arm sofa	56w 36d 32h	25h	52w 21d 19h	337838*	\$1099
H 56" right-arm sofa	56w 36d 32h	25h	52w 21d 19h	695438*	\$1099
I 64" armless sofa	64w 36d 32h	—	64w 21d 19h	955513*	\$999
J 67" left-arm sofa	67w 36d 32h	25h	63w 21d 19h	779549	\$1199
K 67" right-arm sofa	67w 36d 32h	25h	63w 21d 19h	516873	\$1199

A armless chair\*

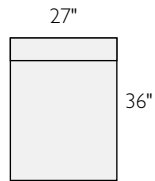

B corner\*

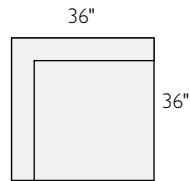

C left-arm chaise\*

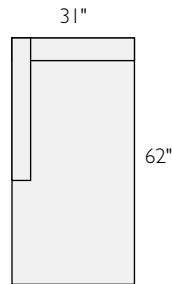

D right-arm chaise\*

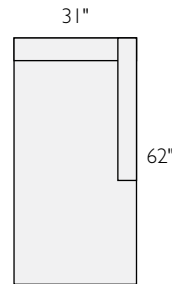

E left-arm wide chaise

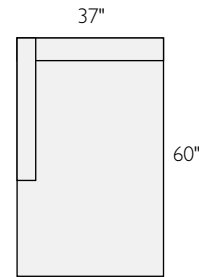

F right-arm wide chaise

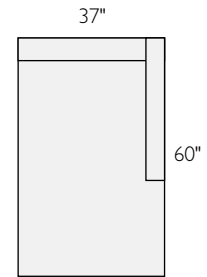

G 56" left-arm sofa\*

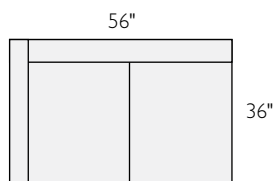

H 56" right-arm sofa\*

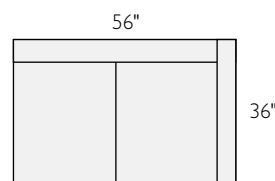

I armless sofa\*

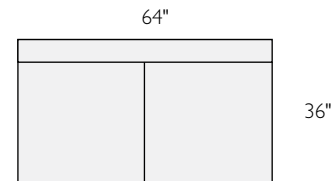

J 67" left-arm sofa

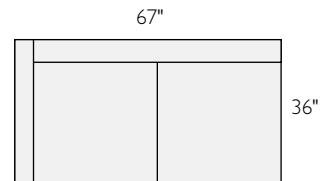

K 67" right-arm sofa

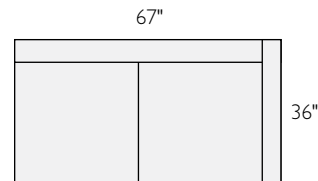

# jasper sectional collection

<i>sofa with chaise sectionals</i>	<i>overall dimensions</i>	<i>arm</i>	<i>seat</i>	<i>Trip</i>	
<b>A</b> sofa with left-arm chaise, 104"	104w 60d 32h	25h	96w 45d 19h	190476	<b>\$2398</b>
<b>B</b> sofa with right-arm chaise, 104"	104w 60d 32h	25h	96w 45d 19h	452722	<b>\$2398</b>

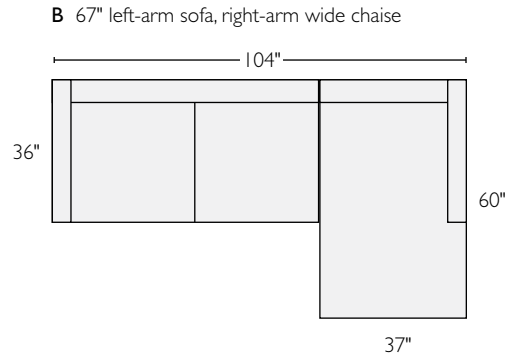
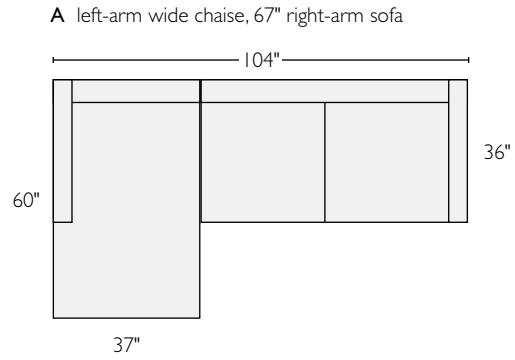

# configuring your custom sectional

We created this guide to help you create the best possible combination of Jasper pieces for a perfect seating space. Draw your space on the graph below — 1 block equals 1 foot — and lay out your space using the 1/4" scale drawings of each component you choose. Remember, left-arm and right-arm configurations refer to the sofa as you are facing it, not sitting on it.

scale: 1 square = 12 inches

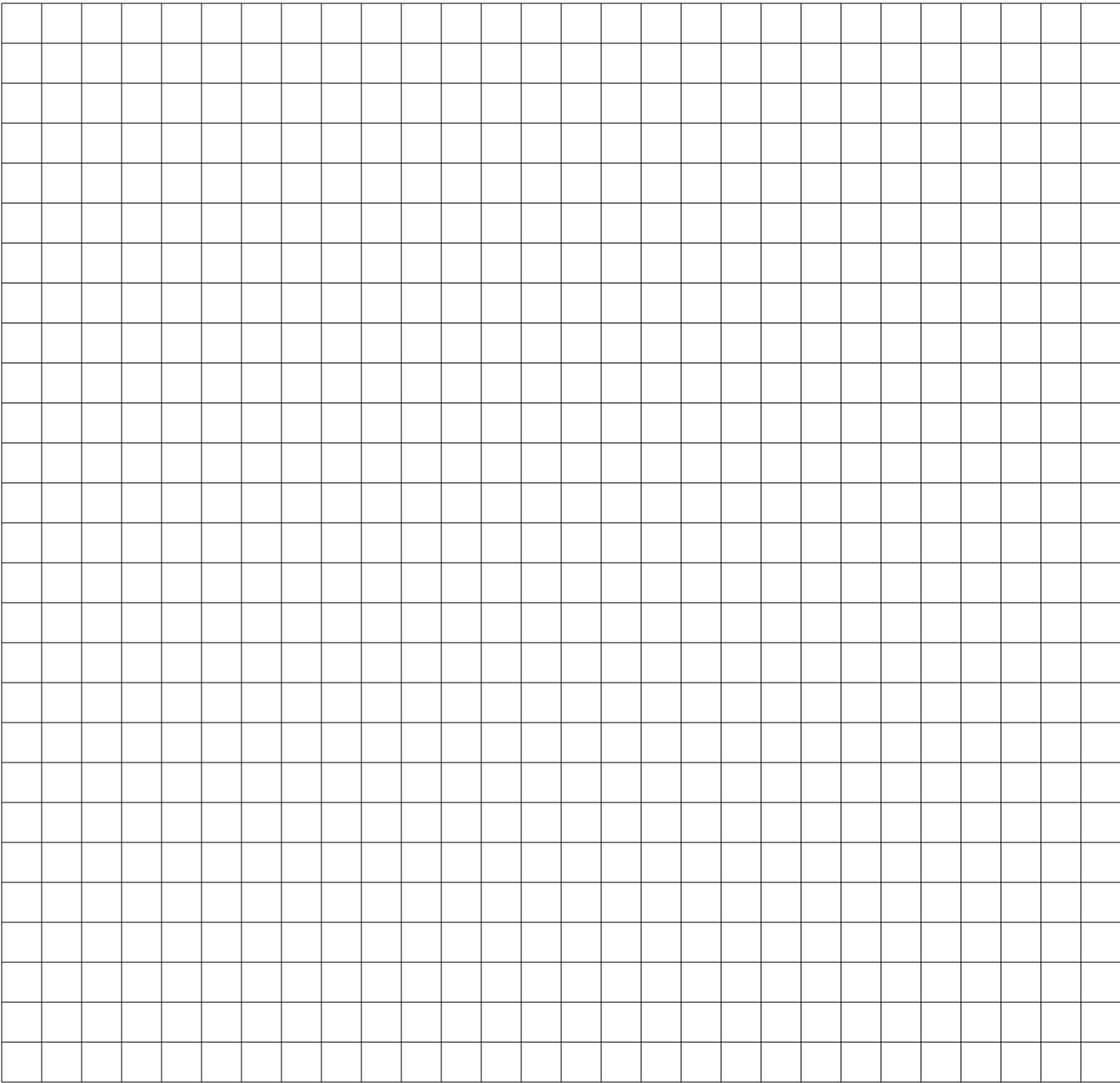

**Notes**

---

---

\_\_\_\_\_  
Sales order #

\_\_\_\_\_  
Design Associate

\_\_\_\_\_  
Customer name

\_\_\_\_\_  
Delivery date