

ANGO PENDANT

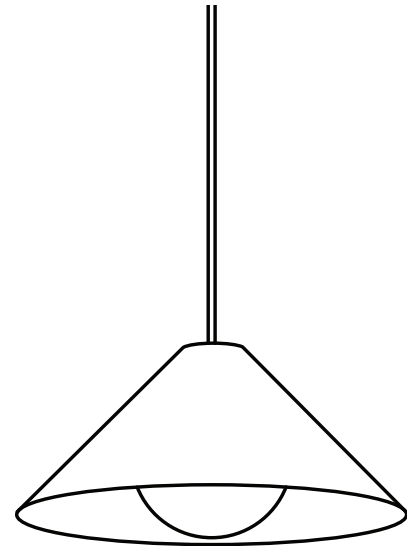
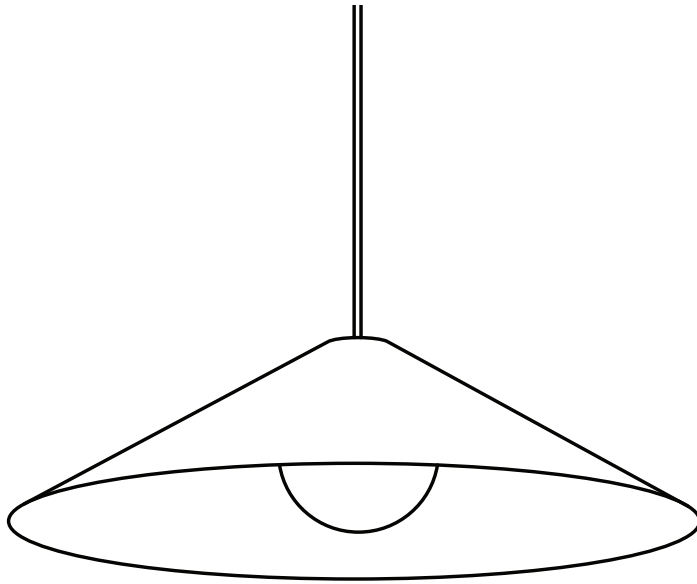

CAUTION

- It is strongly recommended that the hardwire installation of this product is done by a professional.
- Read these safety instructions entirely prior to installation.
- DO NOT BEGIN INSTALLATION UNTIL ALL ELECTRICAL POWER TO THE INSTALLATION SITE HAS BEEN TURNED OFF AT THE CIRCUIT BREAKER!

Recommended Tools

- Flat head screwdriver
- Wire strippers
- Pliers

This Product Includes

- A. Ango canopy assembly
- B. Ango Shade
- C. Glass globe
- D. Bulb
- E. Wire nuts (x2)

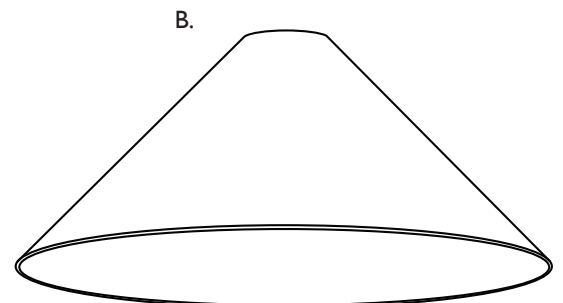
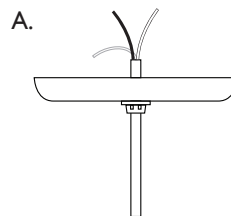

(actual shape may vary)

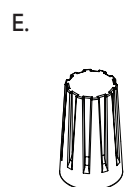
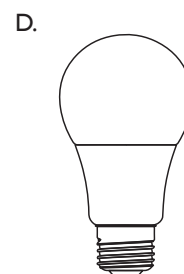
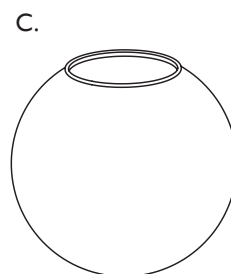

(not to scale)

Installation Instructions

Cord Mount

- 1 Prior to installation, disconnect power at circuit breaker.
- 2 Thread nipple and jam nut into hanger bracket as shown. Leave approximately 3/4" below hanger bracket. Tighten jam nut.
- 3 Pull cord through shade, bushing, canopy, nipple, jam nut and hanger bracket as shown.
- 4 Use a tape measure to determine the desired cord length for your pendant. Position cord clamp with the flange down, near threaded nipple and use pliers to tightly crimp the cord clamp.
- 5 Use wire strippers to cut back the outer protective cover from the wires, then remove approximately 3/4" of the protective cover of each of the individual wires.
- 6 Using the included wire nuts, twist together the wires from the pendant with their corresponding wires from the junction box. Attach the ground wire to the ground screw on the hanger bracket. Tuck the excess wire up into the junction box.
- 7 Slip canopy over nipple and tighten with bushing. Adjust nipple as needed to ensure canopy is flush to the ceiling.

Canopy Assembly

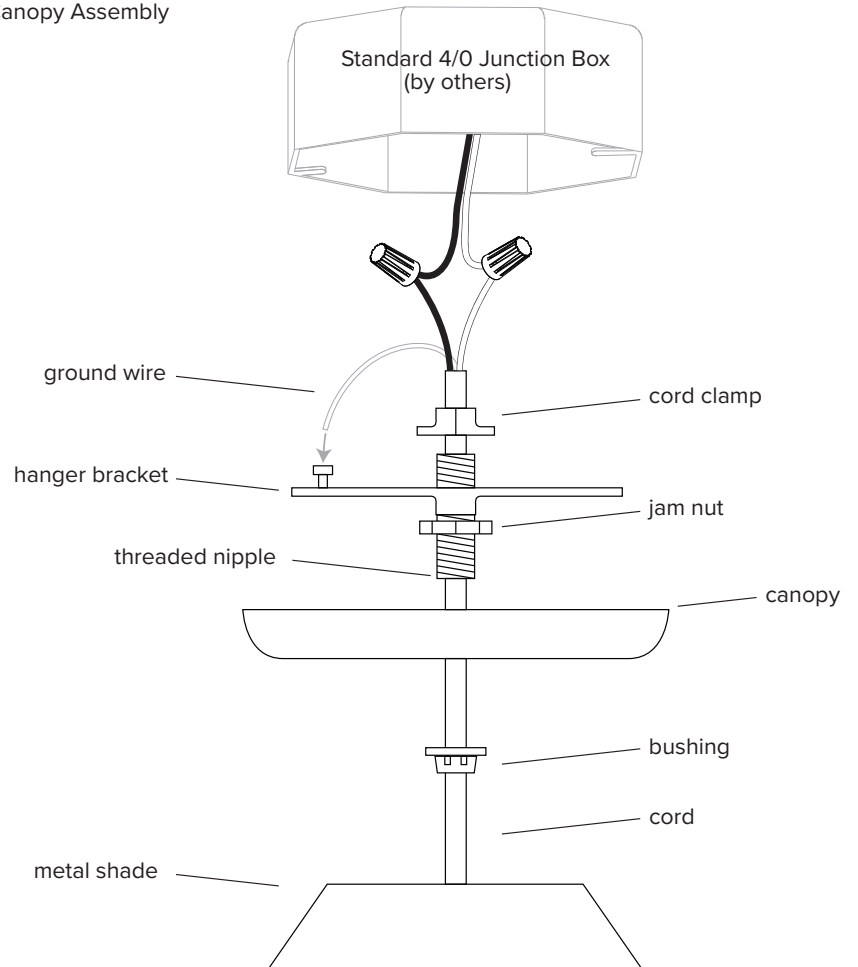

Globe/Pendant

Note: Assembly of this pendant must be completed with at least two people to avoid damage or injury.

- 1 Screw in LED Bulb
- 2 Loosen the set screw on the lower strain relief and remove strain relief from threaded nipple.
- 3 One person will slide the metal shade up the cord, and hold it aloft while the second person places the bulb and globe.
- 4 Carefully place the bulb, socket, and metal stamping into the globe, by inserting bulb and socket followed by one flange of the metal stamping at an angle. Thread lower strain relief back onto the threaded nipple and tighten the set screw. Use caution as the glass globe is fragile.

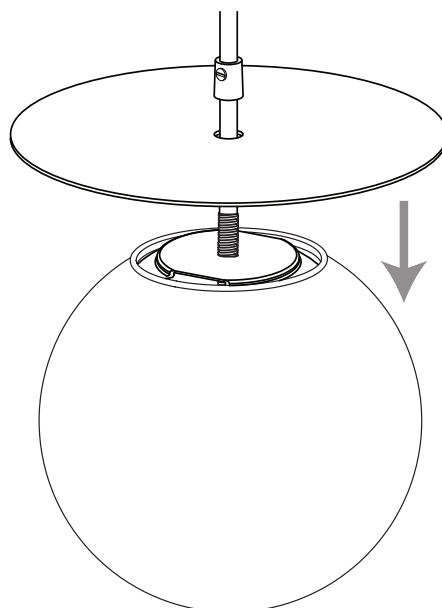
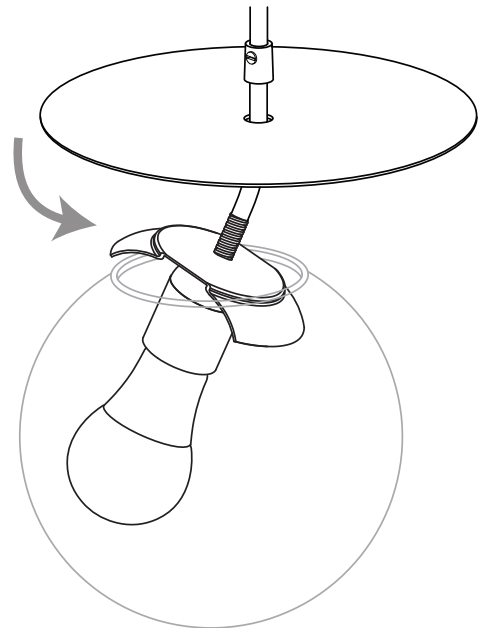
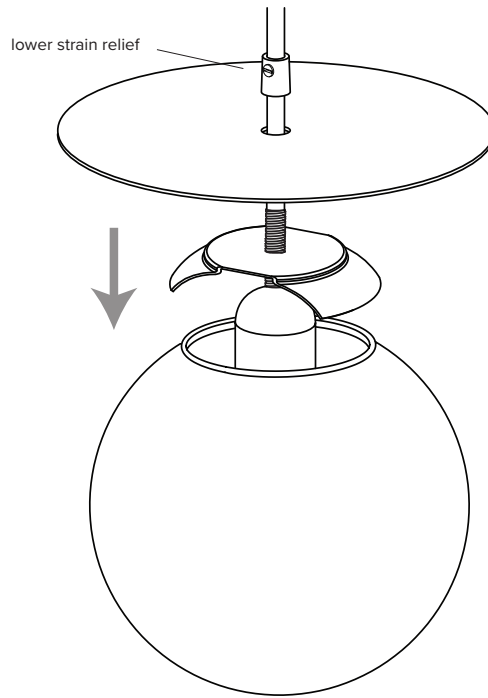

4 Gently lower the shade onto the metal disc until the shade settles into place.

5 Restore power to the breaker.

