

ROUND TRIPLE CEILING CANOPY

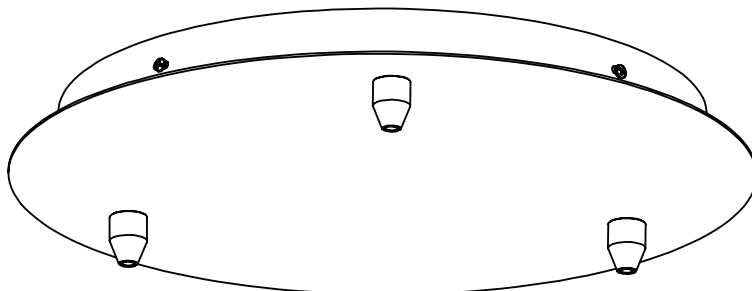

CAUTION:

- It is strongly recommended that installation of this product is done by a professional.
- READ these safety instructions entirely prior to installation.
- DO NOT BEGIN INSTALLATION UNTIL ALL ELECTRICAL POWER TO THE INSTALLATION SITE HAS BEEN TURNED OFF AT THE CIRCUIT BREAKER!

RECOMMENDED TOOLS AND MATERIALS:

Tall step ladder
Tape measure
Wire stripper

Utility knife
Phillips screwdriver
Small blade screwdriver

Marker
Electrical tape
Plain and long-nose pliers

THIS PRODUCT INCLUDES:

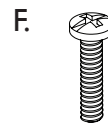
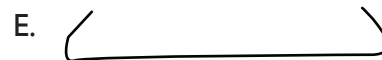
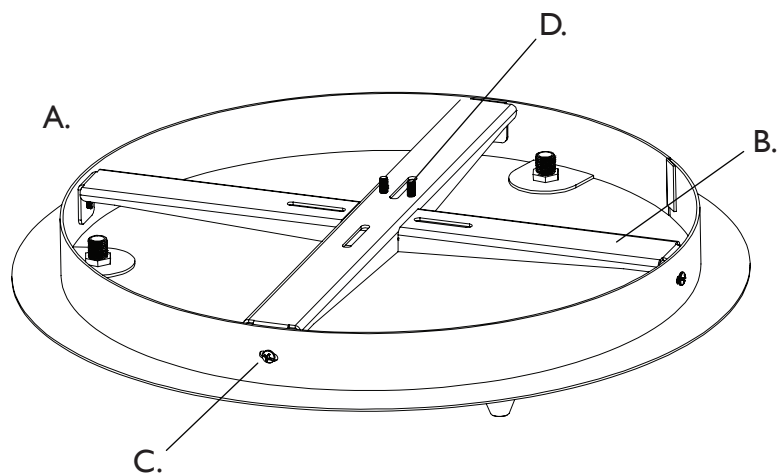

(hardware not to scale)

- A. - Canopy assembly
- B. - Cross-bracket (assembled)
- C. - Assembly screws (x4 - assembled)
- D. - Ground wire screws (x2 - assembled)

- E. - Wire hanging hooks
- F. - Mounting screws (x2)
- G. - Wire nuts (x4)

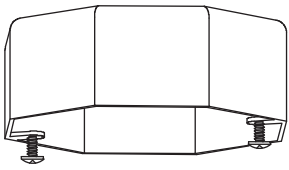

Attention: If you do not have an existing electrical light box in your intended installation site, have one installed by a licensed electrician.

1

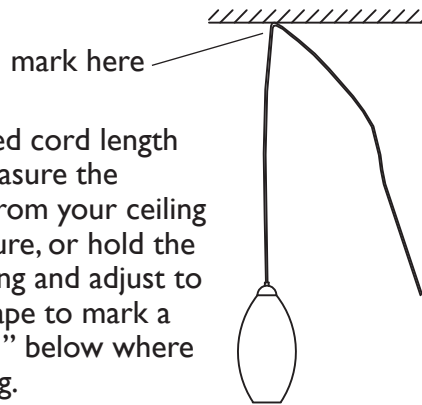

Determine the desired cord length for each pendant. Measure the desired cord length from your ceiling by using a tape measure, or hold the pendant cord to ceiling and adjust to desired length. Use tape to mark a spot on cord about 1" below where it will meet the ceiling.

2

If you are hanging your pendants at varying lengths, lay them on a soft surface and adjust their positions according to your desired arrangement. Use the previously marked pendant as a guide for where to mark the remaining pendants – marks should be in-line with the first marked cord. Note: Remember to compensate for sloped ceilings.

3

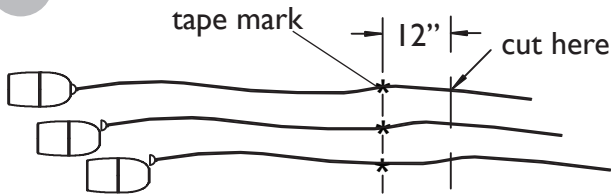

Measure an additional 12" from the tape marks and cut cords at this location. Discard excess wire.

4

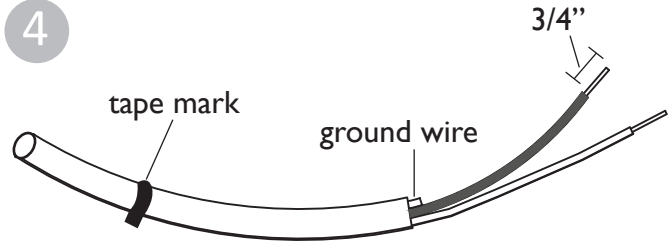

Starting at the cut end, carefully strip back each of the pendant cords' outside insulation to about halfway from the taped marks. If your pendant has a green ground wire, this wire can be cut off entirely as the pendants are not individually conductive. Next, strip back approximately 3/4" of the insulation on each of the remaining two inner wires of each pendant.

5

Next, affix your electrical box's (bare) ground wire to a metal component to effectively ground the unit. For metal electrical boxes, screw on the (bare) ground wire directly to the electrical box. For plastic electrical boxes, after attaching the Mounting Bracket to the ceiling (steps 6-7) screw the ground wire to the canopy's mounting bracket with the provided ground wire screws.

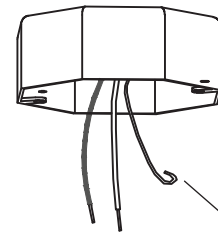

6

bare ground wire

Using the provided mounting screws, screw the cross-bracket to the electrical box through two of the slots in the cross-bracket. Tighten the screws enough to pull the ends of the cross-bracket tight against the ceiling.

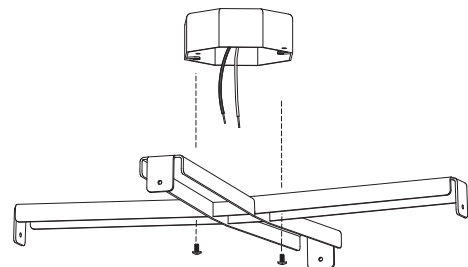

7

Use the two provided wire hanging hooks to hang the canopy cover plate from the cross-bracket. Put the bottom of the hooks into the two triangular holes in the cover plate.

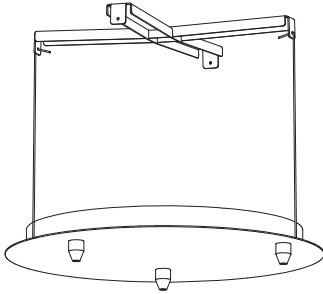

8

Locate the cord-locking collars packaged separately with the individual pendants.

Feed the pendant cords up through the openings in the ceiling plate and slip the locking collars over the cords. Then pull the cords upwards until the tape marks from step 1-2 meet the ceiling plate.

Slide the locking collars down to the ceiling plate and tighten. These collars will set the height of the pendants and prevent the cord from slipping downward.

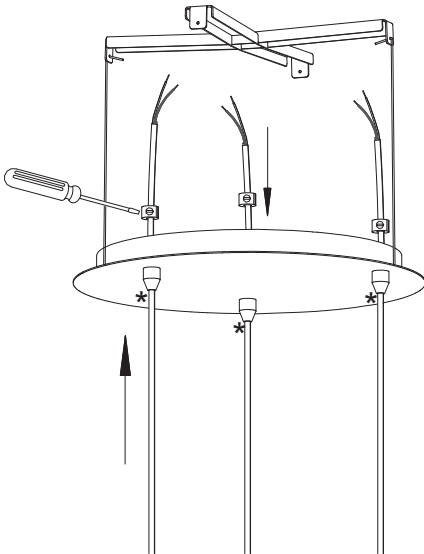

Note: Certain pendants do not come with plastic cord-locking collars. For these pendants, tie a knot in the cord above the ceiling plate to achieve the desired cord length for each pendant.

9

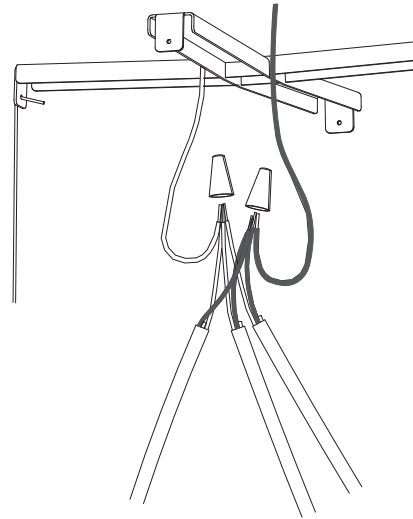

Twist the three black pendant cord wires together with the black (hot) wire from your electrical box. Twist on a yellow wire nut to hold the wires together.

Then twist the three white pendant cord wires together with the white (neutral) wire from your electrical box. Twist on a yellow wire nut to hold the wires together.

10

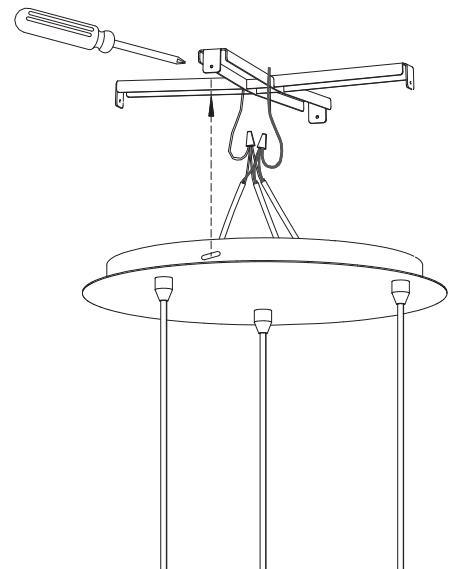

Remove the wire hanging hooks while lifting the cover plate up and around the four tabs on the cross-bracket. Make sure all wires are tucked safely inside. Align the slotted holes on the upper ring of the ceiling plate with the holes in the cross-bracket. Use the four assembly screws to join the two components together. Do not over-tighten.

11

Assess the position of your pendants. If you are not satisfied with the arrangement, determine how much you would like them to move up or down and adjust locking collars or knots accordingly (unscrew cover plate, rehang it with the wires hooks and reposition the cord locking collars or knots).

12

Before testing lights, be sure to turn on the electrical power to the light at the circuit breaker.

SPECIAL CONSIDERATIONS:

When choosing the proper length of each pendant cord, we recommend a minimum of 22" between tables or eating surfaces and the bottom of the pendants.