

COLES VANITIES INSTALLATION AND SPECIFICATIONS



CAUTION

PROFESSIONAL INSTALLATION RECOMMENDED

Please inspect your new vanity prior to installation. Once the vanity has been installed or altered, such as cutting the cabinet's back panel or adhering the top, it cannot be returned. If you notice any damage or defects, please contact us at **800.486.6554** or shop@roomandboard.com for assistance.

Moving and Storage

- Keep in original packaging until installation to protect from damage.
- Do not stack anything on top of the packaging.
- Use a two-person team to lift and move.

Installation Requirements

- Professional installation with a two-person team.
- Water supply and plumbing installed according to local code.
- Level floor and plumb walls at installation site.

Vanity Installation Recommendations

- Cut or drill holes in the back or bottom panel of the vanity cabinet to accommodate plumbing.
- Attach the vanity cabinet securely to the wall using appropriate hardware for your wall material.
- If needed, use the supplied leveler feet to accommodate a floor that is not level. To use, remove plastic foot caps, insert the levelers and set at the desired height.

Top Installation Recommendations

- Apply a nickel-sized amount of clear 100% silicone to all four corners of the top edge of the vanity cabinet.
- Using a two-person team, lift and place the vanity top. Lower it slowly; do not drop it onto the vanity cabinet.
- Wipe off excess silicone immediately.

Backsplash and Side Splash Installation Recommendations

- Apply a nickel-sized amount of clear 100% silicone every eight to ten inches on the wall where the backsplash will be installed.
- Install the backsplash by gently pushing it onto the wall and centering it on the top.
- If you selected a left overhang or right overhang top, a side splash is included. Install the side splash after the backsplash.
- Once cured, run a small bead of 100% clear silicone along the joint where the backsplash and optional side splash meet the vanity top.

For wood and quartz cleaning and care information, visit roomandboard.com/care.

Coles Vanities

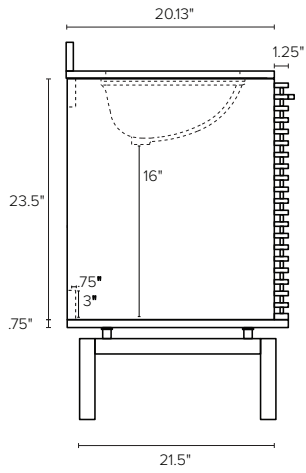

Side view measurements apply to all vanity sizes and both sink shapes.

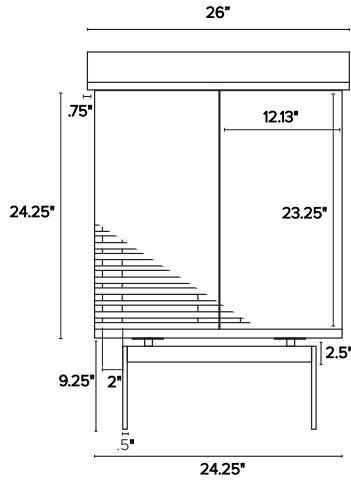

26w 21.75d 34h Single-Sink Vanity
Tops with an overhang left side only or right side only are 25.25" wide.

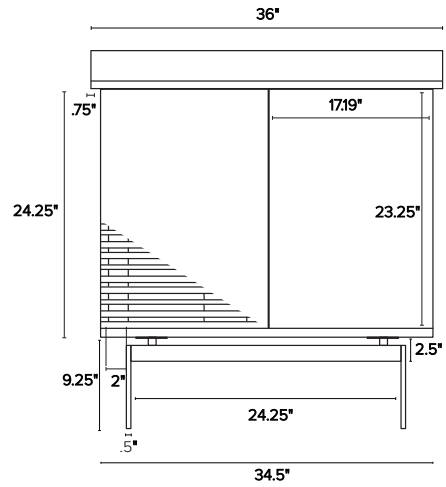

36w 21.75d 34h Single-Sink Vanity
Tops with an overhang left side only or right side only are 35.25" wide.

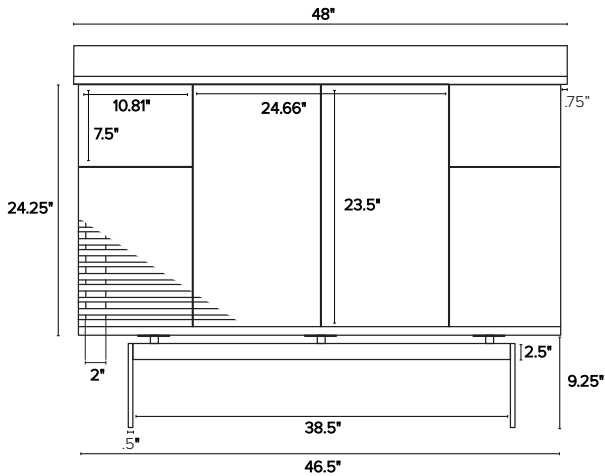

48w 21.75d 34h Single-Sink Vanity
Tops with an overhang left side only or right side only are 47.25" wide.

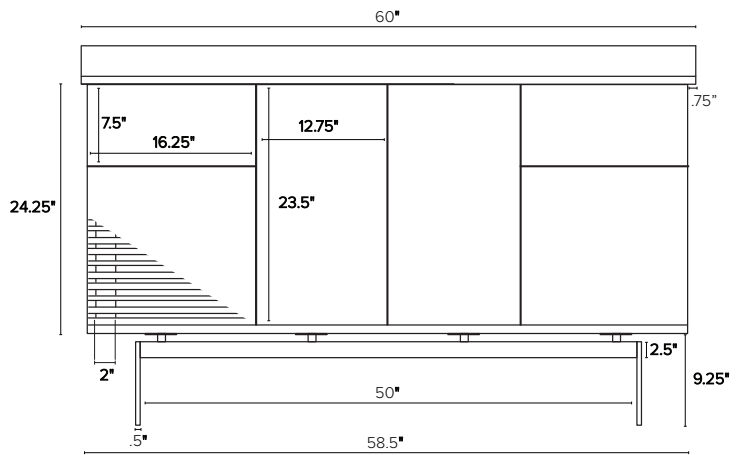

60w 21.75d 34h Single-Sink Vanity
Tops with an overhang left side only or right side only are 59.25" wide.

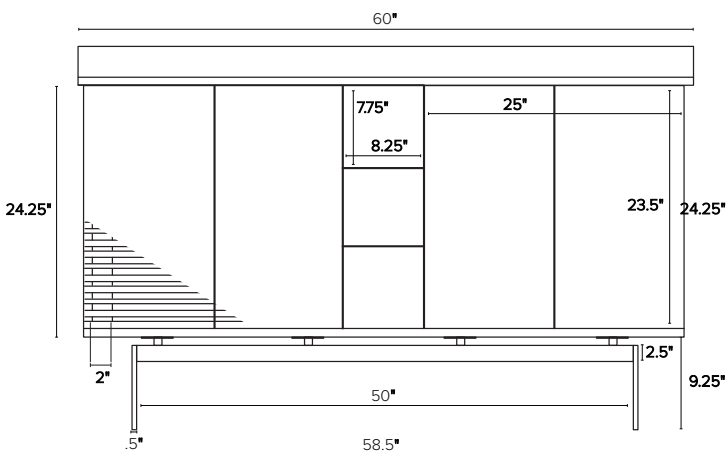

60w 21.75d 34h Double-Sink Vanity
Tops with an overhang left side only or right side only are 59.25" wide.

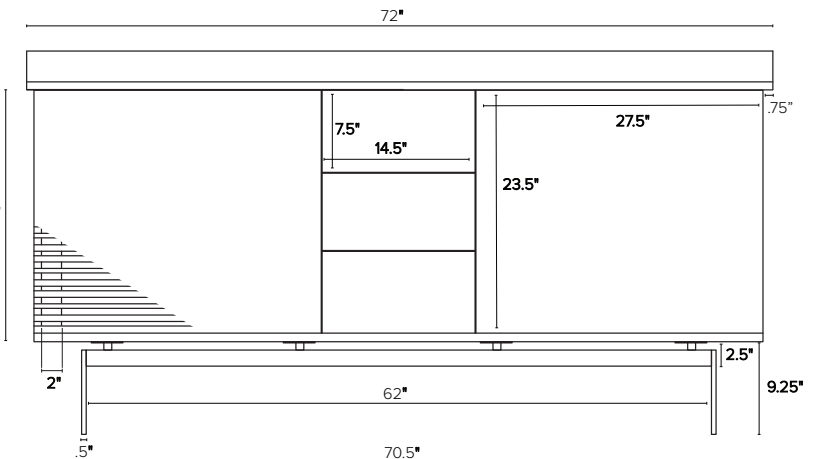

72w 21.75d 34h Double-Sink Vanity
Tops with an overhang left side only or right side only are 71.25" wide.

Vanity Tops and Sinks

- All vanity tops available with left and right side overhang, no overhang, overhang left side only or overhang right side only.
- Backsplash included; side splash included for overhang left side only or overhang right side only.

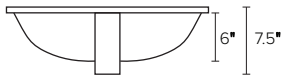

Rectangular sink front view

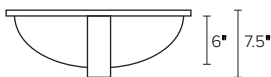

Oval sink front view

26" and 36" RECTANGULAR SINKS, single faucet hole

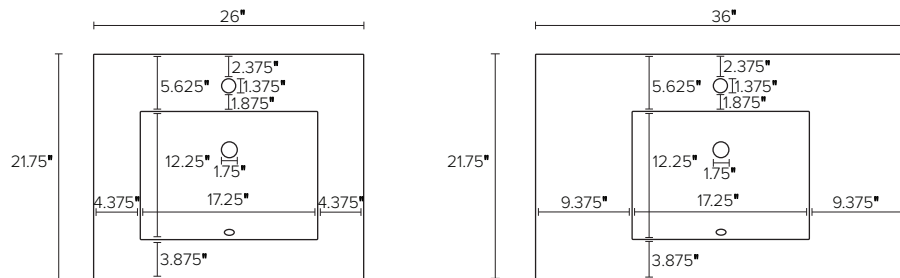

26" and 36" RECTANGULAR SINKS, 8" spread faucet holes

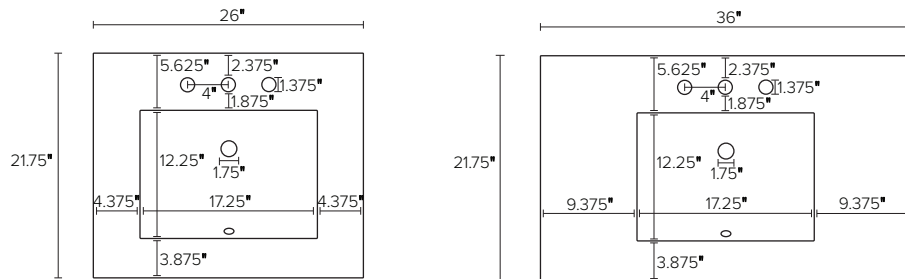

26" and 36" OVAL SINKS, single faucet hole

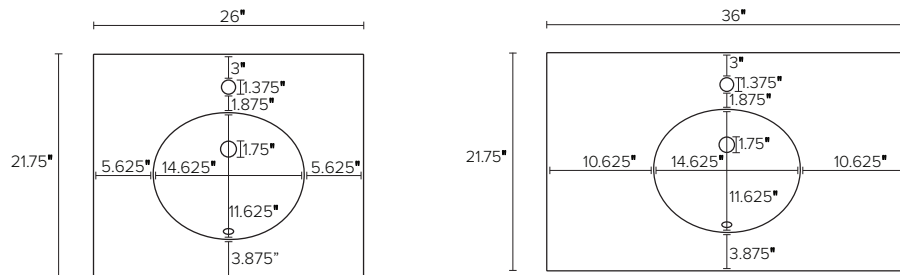

26" and 36" OVAL SINKS, 8" spread faucet holes

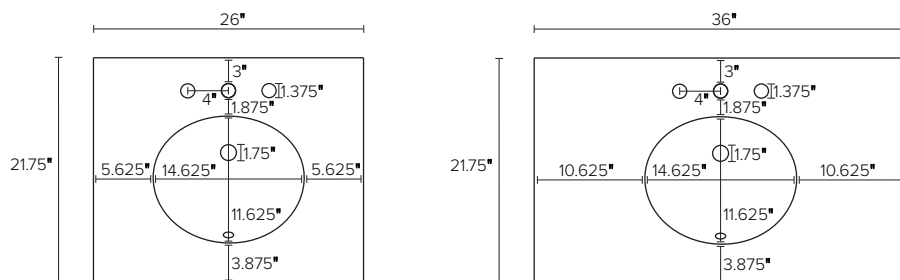

26w 21.75d 34h Single-Sink Vanity
Tops with no overhang are 24.5" wide;
tops with an overhang left side only or
right side only are 25.25" wide.

36w 21.75d 34h Single-Sink Vanity
Tops with no overhang are 34.5" wide;
tops with an overhang left side only or
right side only are 35.25" wide.

Vanity Tops and Sinks

- All vanity tops available with left and right side overhang, no overhang, overhang left side only or overhang right side only.
- Backsplash included; side splash included for overhang left side only or overhang right side only.

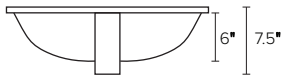

Rectangular sink front view

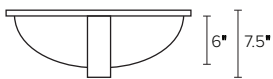

Oval sink front view

48" RECTANGULAR SINKS, single faucet hole

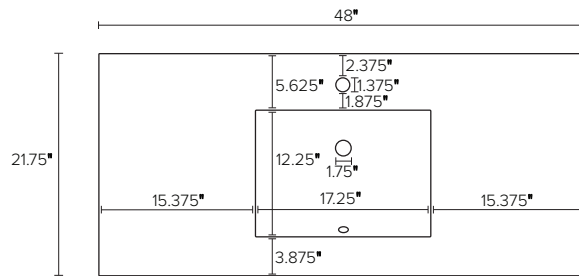

48" RECTANGULAR SINKS, 8" spread faucet holes

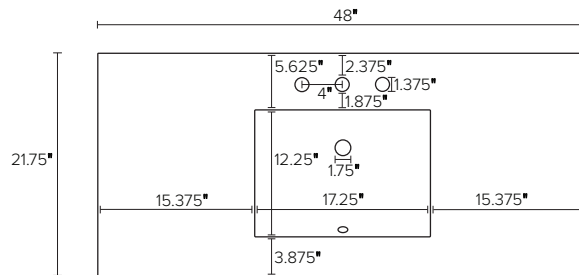

48" OVAL SINKS, single faucet hole

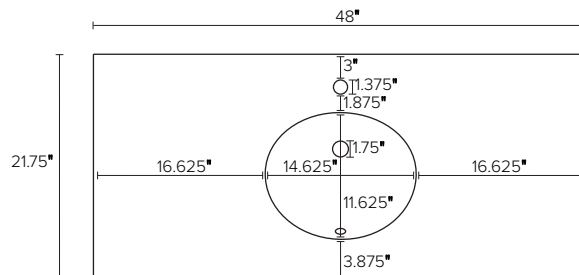

48" OVAL SINKS, 8" spread faucet holes

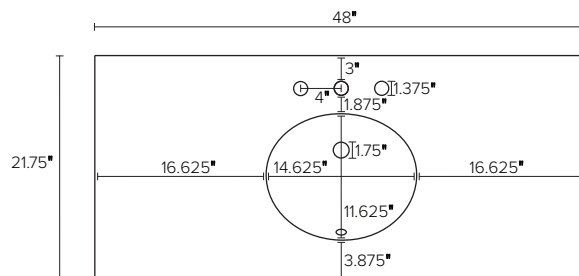

48w 21.75d 34h Single-Sink Vanity

Tops with no overhang are 46.5" wide; tops with an overhang left side only or right side only are 47.25" wide.

Vanity Tops and Sinks

- All vanity tops available with left and right side overhang, no overhang, overhang left side only or overhang right side only.
- Backsplash included; side splash included for overhang left side only or overhang right side only.

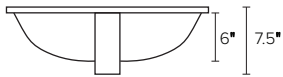

Rectangular sink front view

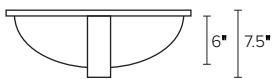

Oval sink front view

60" RECTANGULAR SINKS, single faucet hole

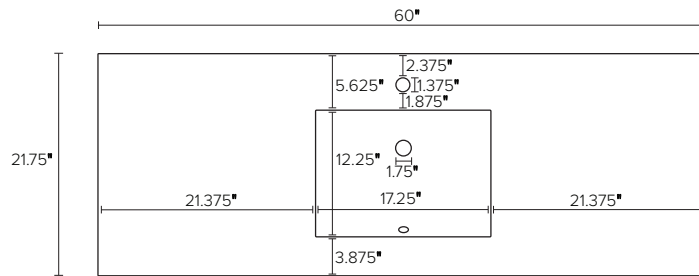

60" RECTANGULAR SINKS, 8" spread faucet holes

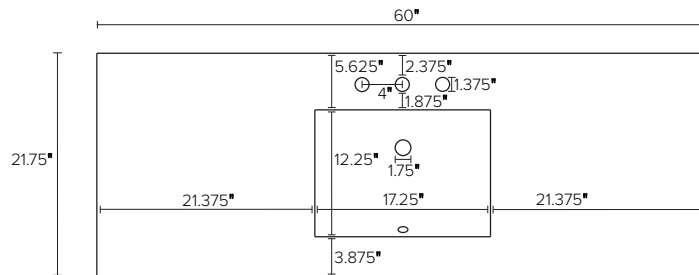

60" OVAL SINKS, single faucet hole

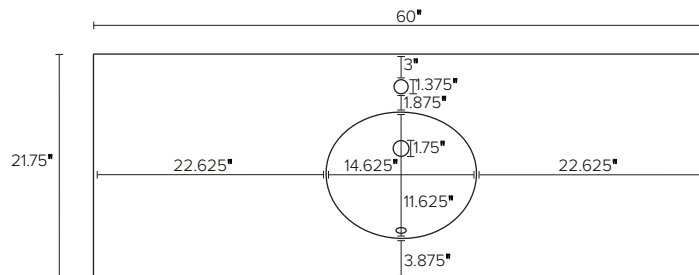

60" OVAL SINKS, 8" spread faucet holes

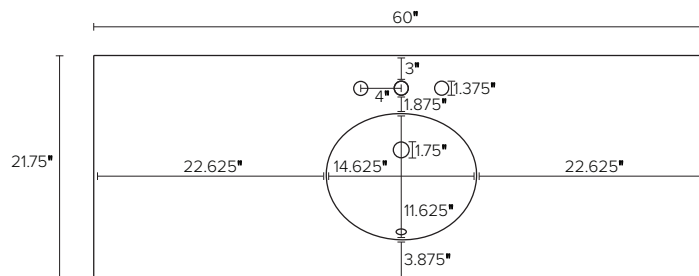

60w 21.75d 34h Single-Sink Vanity

Tops with no overhang are 58.5" wide; tops with an overhang left side only or right side only are 59.25" wide.

Vanity Tops and Sinks, continued

- All vanity tops available with left and right side overhang, no overhang, overhang left side only or overhang right side only.
- Backsplash included; side splash included for overhang left side only or overhang right side only.

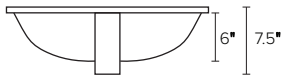

Rectangular sink front view

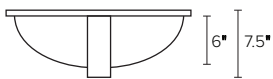

Oval sink front view

60" RECTANGULAR SINKS, single faucet hole

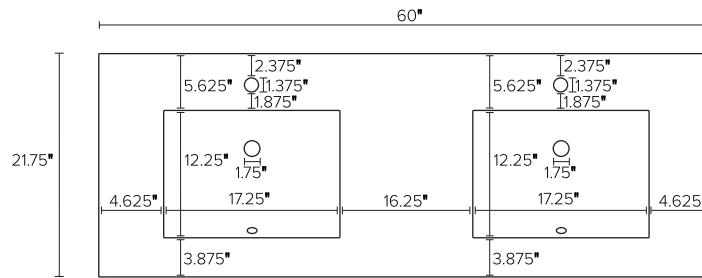

60" RECTANGULAR SINKS, 8" spread faucet holes

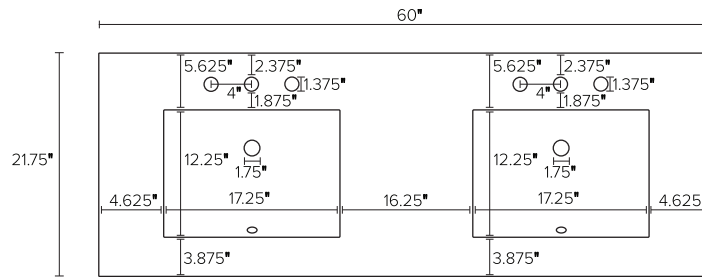

60" OVAL SINKS, single faucet hole

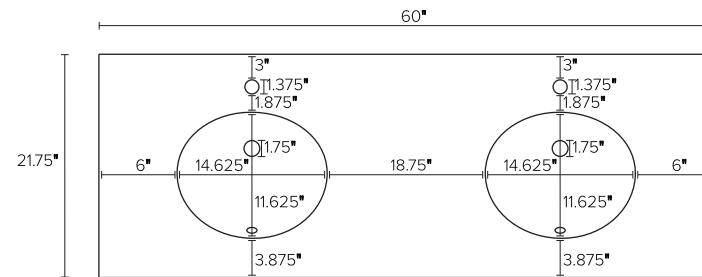

60" OVAL SINKS, 8" spread faucet holes

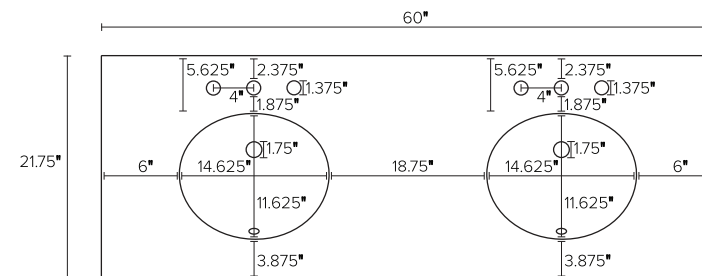

60w 21.75d 34h Double-Sink Vanity

Tops with no overhang are 58.5" wide; tops with an overhang left side only or right side only are 59.25" wide.

Vanity Tops and Sinks, continued

- All vanity tops available with left and right side overhang, no overhang, overhang left side only or overhang right side only.
- Backsplash included; side splash included for overhang left side only or overhang right side only.

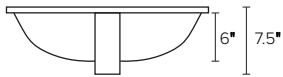

Rectangular sink front view

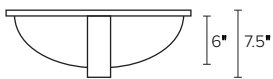

Oval sink front view

72" RECTANGULAR SINKS, single faucet hole

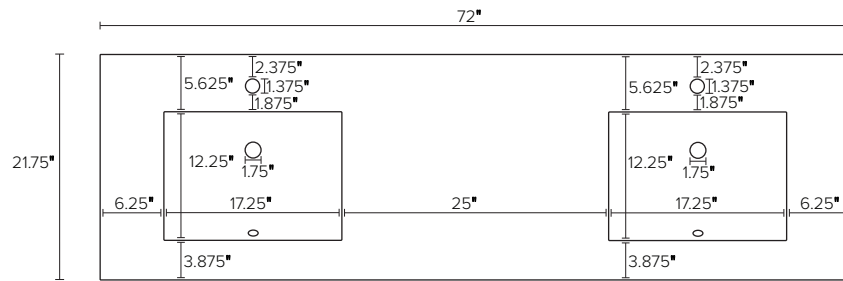

72" RECTANGULAR SINKS, 8" spread faucet holes

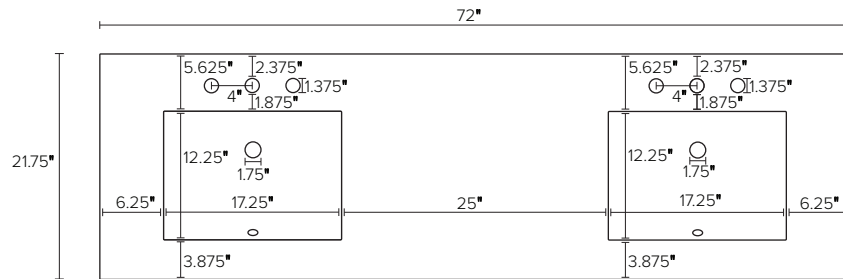

72" OVAL SINKS, single faucet hole

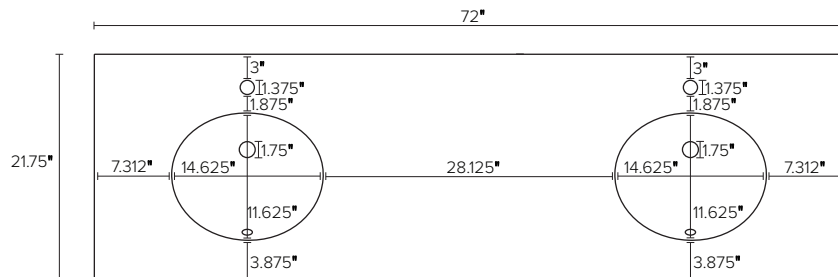

72" OVAL SINKS, 8" spread faucet holes

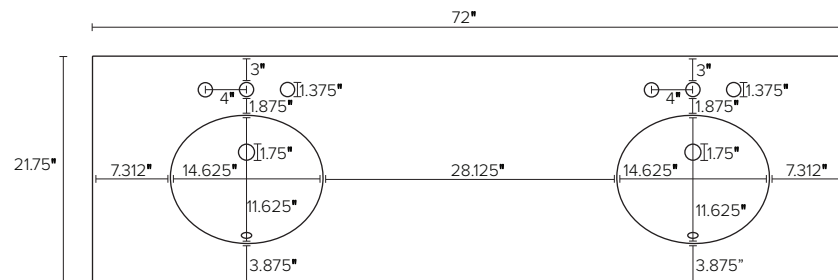

72w 21.75d 34h Double-Sink Vanity

Tops with no overhang are 70.5" wide; tops with an overhang left side only or right side only are 71.25" wide.